



JSDA⁺

JSD⁺E

AC Servo System



TECO

JSDA-200A3

CN 3

CN 4

88888

POWER

MODE ▲ ▼ ENTER

CHARGE

CN 1

CN 2

88888

TECO

88888

TECO

CN 3

CN 4

CN 1

CN 2

88888

TECO

POWER

CN 3

CN 4

CN 1

CN 2

88888

TECO

88888

TECO

CHARGE

POWER

CN 3

CN 4

CN 1

CN 2

CAUTION
TECO
JSDA-200A3
TECO

Contents

03 | JSDE+ Series Servo Amplifier

06 | JSDA+ Series Servo Amplifier

12 | JSMA Series Servo Motor

JSDE⁺ Series

Standard Servo Amplifier



Frame	1				2	
JSDEP	10A	15A	20A	30A	50A3	75A3
Max. Capacity	100W	400W	750W	1kW	2kW	3kW

Model Designation

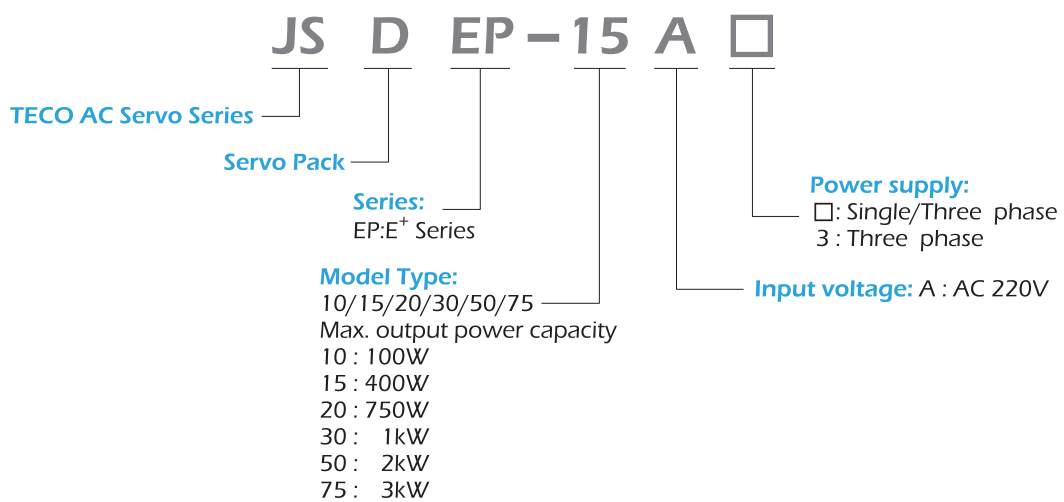

Friendly Interface for Scaling of Encoder Feedback



The scaling of the encoder feedback pulse could be set by parameter, with a range from 0 to the encoder maximum pluse per rotation.

Reserved Braking resistor Installation space

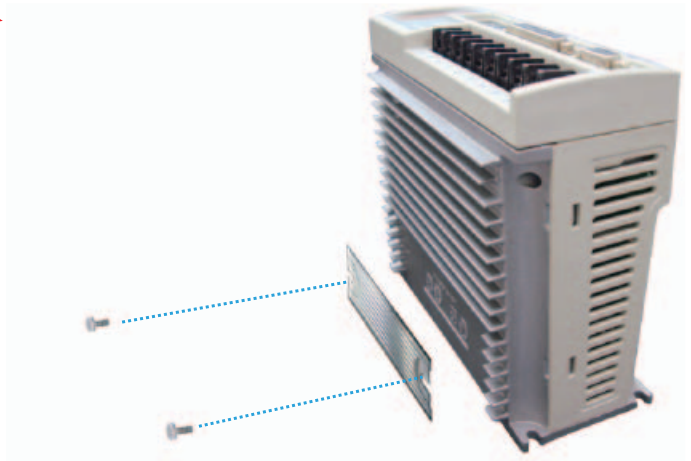

Notch Filter

Notch filter can be used to reduce or eliminate the vibration caused by mechanical resonance.

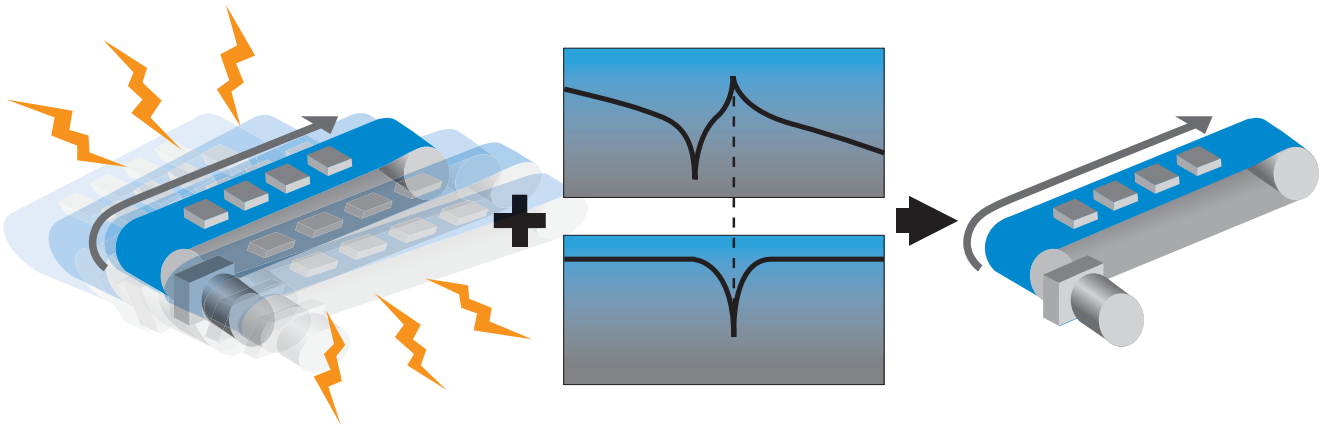

JSDE+ Dimension

Model	H	H1	W
JSDEP-10A/15A	160	152	67
JSDEP-20A/30A	160	152	80

Unit:mm

Model	H	H1	W
JSDEP-50A3/75A3	206	195	80

Unit:mm

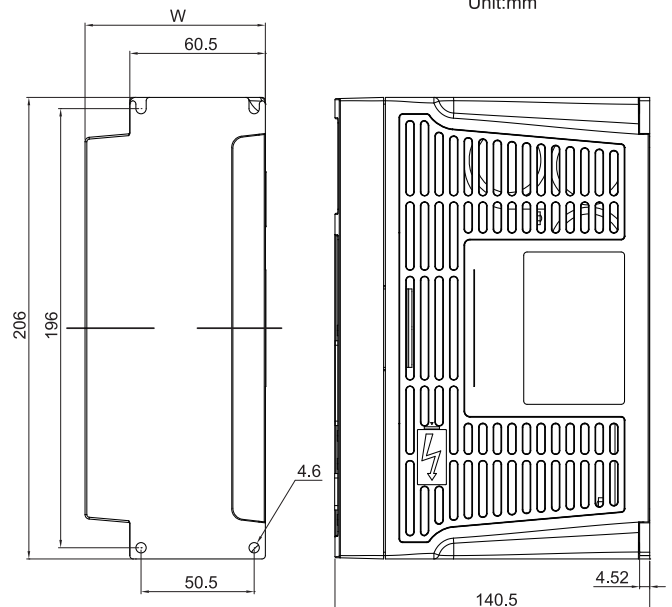
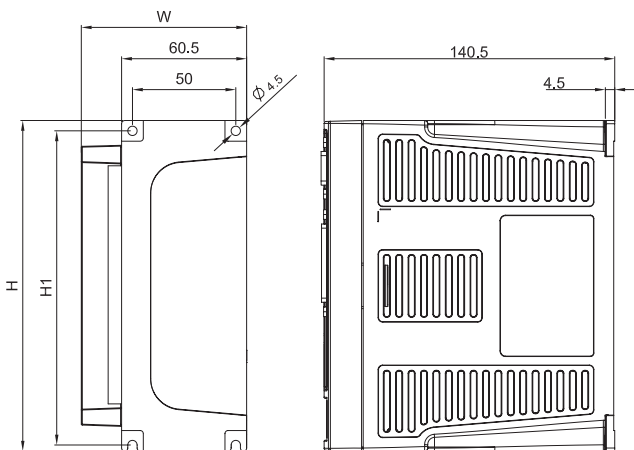

JSDE⁺ Specifications

	Servo Amplifier model JSDEP-□□□□	10A	15A	20A	30A	50A3	
Basic Specification	Max. Applicable Servo Motor Capacity[KW]	0.1	0.4	0.75	1.0	2.0	
	Continuos Current output[A rms]	0.94	2.5	4.4	5.16	9.5	
	Max. output Current[A rms]	2.82	7.5	13.2	15.5	28.5	
	Power Supply	Main Circuit R, S, T	Single Phase/Three Phase AC 170 ~ 253V				Three Phase AC 170 ~ 253V
			50 / 60Hz ±5%				
		Cooling System	Natural Air Circulation		Fan Cooling		
		Control Mothed	Three Phase full-wave rectification IGBT-PWM(SPWM)				
	Feedback[Encoder Resolution]	Incremental Encoder : 2500ppr / 8192ppr					
Common Function	LED Display	Charge / Power lamps ; Five 7-segment LEDs ; Four function keys					
	Control Mothed	Position(External Pulse Command/Internal Pulse Command), Speed/Torque and Dual control mode(P/S · S/T · P/T)					
	Regenerative Discharge	Built-in braking transistor (External braking resistor available)					
	Protective Function	Under voltage, Over voltage, Over load, Over current, Encoder error, Abnormal DI/DO programming, Memory abnonal, Emergency stop, Pulse deviation, Over speed, CPU abnonal, Limit switch error, Over heat...etc.					
	Communication interface	RS-232 / RS-485 (Modbus protocol)					
Position control	Command Source	External pulse train / Internal parameter (32 steps)					
	Input Signals	Type	Positive / Negative edge trigger : Sign+Pulse train, CCW+CW pulse train, 90° phase difference 2-phase pulse(A phase+B phase)				
		Form	Line Driver (+5V Level) 、 Open Collector (+5 ~ +24V Level)				
		Frequency	4Mpps(Line driver) / 200Kpps(Open collector)				
	Electronic Gear Ratio	1/200 A/B 200 (A=1 ~ 50000 ; B=1 ~ 50000)					
	Position Time Constant	smoothing : 0 ~ 10sec					
	Final Position Tolerance	0 ~ 50000 Pulse					
	Feed Forward Compensation	0 ~ 100 %					
Homing Function	Set by parameter						
Speed control	Command Source	External analog signal / Internal parameter(3 speed set-up)					
	Analog Input Signals	Voltage Range	0 ~ ±10Vdc / 0 ~ 4500rpm (Set by parameter)				
		Impedance	10KΩ				
	Speed Control Range	1 : 5000 (Internal command) / 1 : 2000 (External command)					
	Speed Fluctuation Rate	Load fluctuation : 0 ~ 100% ±0.03% or less (at rated speed)					
		Power fluctuation : ±10% ±0.2% or less(at rated speed)					
		Ambient temperature fluctuation : 0 ~ 50°C ±0.5% or less (at rated speed)					
	Accel/Decel. Time Constant	Linear : 0 ~ 50sec, S-Curve : 0 ~ 5sec, Smoothing : 0 ~ 10sec					
Frequency Characteristic	600Hz (at J _L =J _M)						
Torque Limit Operation	External analog signal / Internal parameter						
Zero Speed / Speed Reach Range	0 ~ 4500rpm (Set by parameter)						
Torque control	Command Source	External analog signal					
	Analog Input Signals	Voltage Range	0 ~ ±10Vdc / 0 ~ ±300%				
		Impedance	10KΩ				
	Accel/Decel. Time Constant	Linear : 0 ~ 50sec					
	Speed Limit Operation	External analog signal / Internal parameter					
Torque Reach Range	0 ~ 300% (set by parameter)						
I/O signals	Position Output	Output Signal	Phase A · B · Z Line Driver / Phase Z Open Collector				
		Scaling of encoder feedback pulse	Set up of any value is enabled (encoder pulse is the max.)				
	Digital Input [NPN/PNP]	Programmable 6 Points	Servo on, Alarm reset, P/PI switching, Forward/Reserve limit switch, External torque limit, Pulse deviation clear, Servo lock, Emergency stop, Speed command selection, Control mode switching, Pulse command inhibit, Gain switching, Electronic gear ratio setting, Internal pulse command trigger, Internal pulse sommand pause, Homing mode positioning, External reference signal, Internal position command switching, Speed/Torque command reverse, Torque mode forward / reverse start...etc.				
Digital Output [Photocoupler]	Programmable 3 Points	Servo ready, Servo alarm, Zero speed, Brake interlock, Speed reach, Positioning completed, Homing completed, Torque reach					
Environment	Installation Site	Indoor location(Avoiding direct sunshine) No corrosive liquid and gas(avoiding oil mist, flammable gas, dust)					
	Aititude	Altitude 1000M or lower above sea level					
	Temperature	Operating temperatue : 0 ~ 50°C ; Storage temperature : -20 ~ +65°C					
	Humidity	90%RH or less(No condensation)					
	Vibration	10 ~ 57Hz : 20m/s ² ; 57 ~ 150Hz : 2G					
Certification	CE	In compliance with EN61800-3 and EN61800-5-1					
	UL	UL508C					

JSDA⁺ Series

Advanced Servo Amplifier



Frame	1				2			3	4		
200V	10A	15A	20A	30A	50A3	75A3	100A3	150A3		200A3	300A3
400V	N/A	N/A	N/A	N/A	25B	35B	50B*	75B*	100B*	N/A	N/A
Max. Capacity	100W	400W	750W	1kW	2kW	3kW	4.4kW	5.5kW	7.5kW	7.5kW	15kW

Note : * Coming soon.

Model Identification

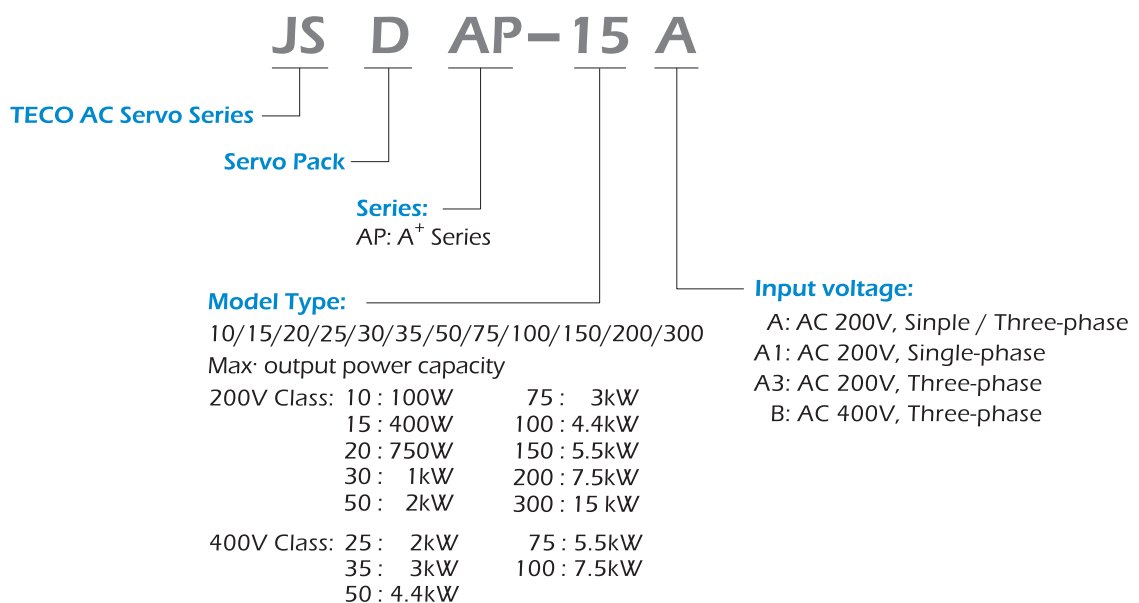

Excellent Performance

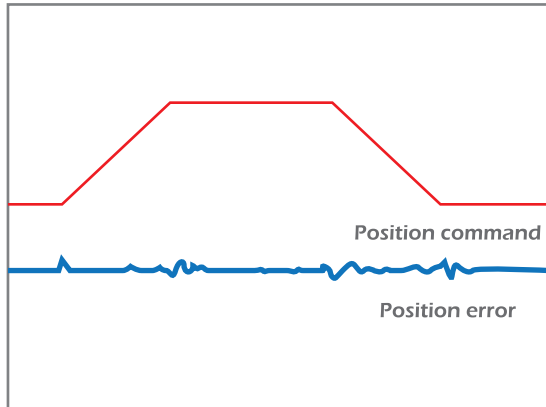

Performance of the position doubled in comparison with current models by adoption of the optimized position and speed control algorithm.

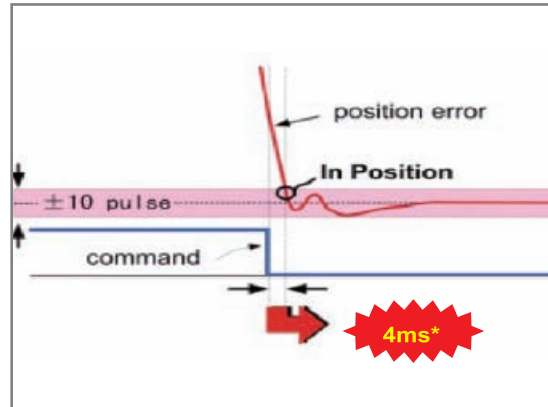

A optimized method drastically shortens positioning settling time for equipment.

*Determined under field conditions.

High Resolution Encoders



Built-in Regenerative Resistor



*Built-in regenerative resistor below JSDAP-150A3

Battery Module for Absolute Encoder



Frame 1



Frame 2



Frame 3

Auto Motor Recognition

Through 17-bit and 15-bit encoders, servo motor can be identified.



Applications

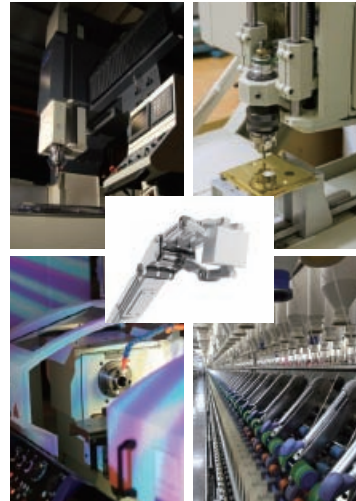

- Mechanical arm
- Engraving machine
- Computerized flat knitting machine
- CNC Lathe machine
- CNC wire cutting machine
- Injection molding machine
- PCB Router machine

JSDA+ Dimension

JSDAP-10A/15A/20A/30A

Model	W
JSDAP-10A/15A	69.5
JSDAP-20A/30A	80.5

Unit:mm

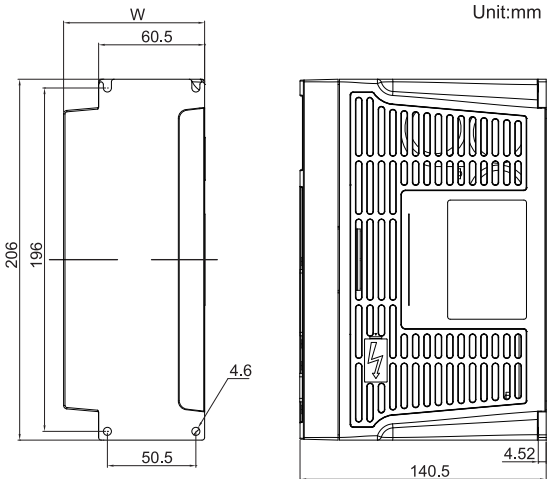

JSDAP-50A3/75A3/100A3/25B/35B/50B

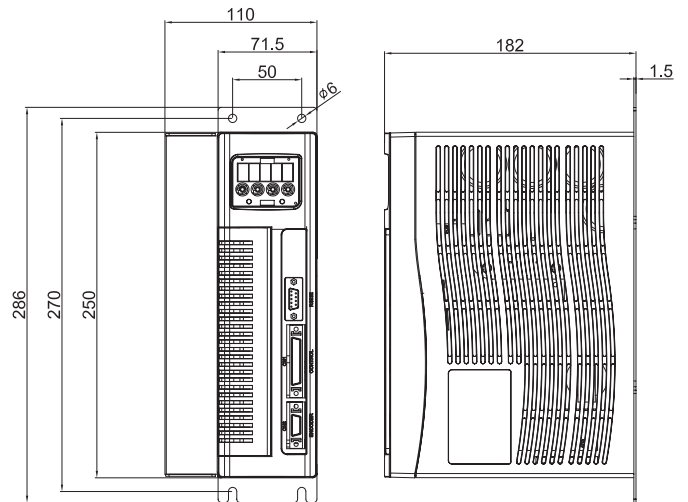

JSDAP-150A3/75B/100B

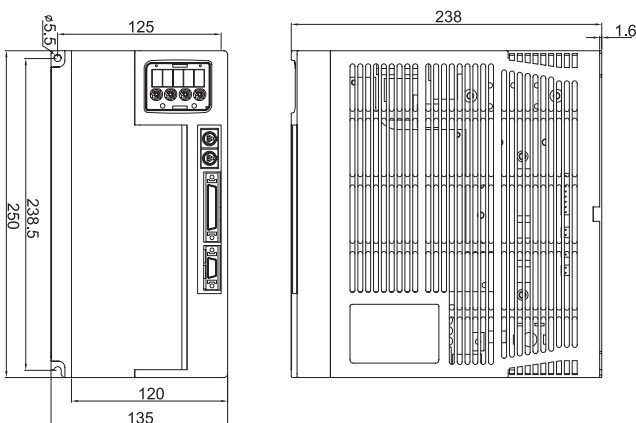

JSDAP-200A3/300A3

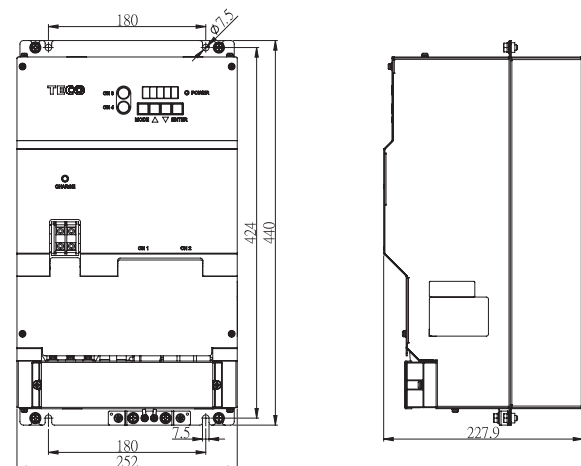

JSDA⁺ Specifications

Servo Drives for JSDA□□□□		200V Class										400V Class					
		10A	15A	20A	30A	50A3	75A3	100A3	150A3	200A3	300A3	25B	35B	50B*	75B*	100B*	
Basic Specifications	Max. Applicable Servo Motor Capacity [KW]	0.1	0.4	0.75	1	2	3	4.4	5.5	7.5	15	2	3	4.4	5.5	7.5	
	Continuous Output Current [A rms]	0.94	2.5	4.4	5.16	9.5	15	23	33.2	42.1	78	6	8	11.5	16	22	
	Max. Output Current [A rms]	2.82	7.5	13.2	15.5	28.5	42	59.8	86.3	109.5	170	15.6	20.8	29.9	41.6	57.2	
	Power Supply	Main Circuit R/S/T	Single/Three-Phase AC 200 ~ 230V					Three-Phase AC 200 ~ 230V					Three-Phase AC 380~480V				
		Control Circuit r/s	50/60Hz ±5%										DC 24V, ±10%				
	Cooling System		Natural Air Cooling					Fan Cooling									
		Control of Main Circuit	Three-phase full-wave rectification IGBT- SVPWM Control(Sine-wave current drive way)														
Feedback (Encoder Resolution)	LED Display	Incremental type : 2500ppr / 8192ppr / 15-bit (ABS) / 17-bit															
Internal Functions	Control Mode	Main/ control circuit power indicator; 5 digital seven-segment display ; four function key.															
	Control Mode	Position (External pulse command), Position (Internal position command), Speed, Torque and Dual mode switching (Position/Speed, Speed/Torque, Position/ Torque)															
	Regenerative Brake	Built-in braking transistor and resistor / External braking resistor									Built-in braking transistor / External braking resistor		Built-in braking transistor and resistor / External braking resistor				
	Dynamic Brake	Built-in dynamic braking; Power-off, Servo-off, Drive disable and Alarm occurred															
	Protection Function	Low Voltage, Over Voltage, Overload, Over Current, Encoder signal error, Multi-function contact setting error, Memory error, Emergency stop, Position error, Motor Over Speed, CPU error, Drive disable, Overheat. 16 Types of Alarm Functions															
	Communication Interface	RS-232 / RS-485 (Modbus protocol)															
	Command Source	External command/ Pulse command / 32-Stage internal register command															
Position Control Mode	Input Signals	Type	Positive/Negative Edge Trigger Type : Direction + Pulse, CW/CCW Pulse , Phase difference pulse (A Phase + B Phase)														
		Form	Line Driver (+5V), Open Collector (+5 ~ +24V)														
		Frequency	4Mpps(Line Driver) / 200Kpps(Open Collector)														
	Electronice Gear Ratio	1/400 ≤ A/B ≤ 400 (A-1 ~ 50000 ; B-1 ~ 50000)															
	Position Time Constant	Ripple Time Constant : 0 ~ 10sec															
	Final Position Tolerance	0 ~ 50000 Pulse															
	Feed Forward Compensation	0 ~ 100 %															
Homing Function	Set by internal parameters																
Speed Control Mode	Command Source	External analog Command / 3-Stage internal speed command															
	Analog Input Signals	Voltage Range	0 ~ ±10Vdc / 0 ~ 6000rpm (set by internal parameters)														
		Impedance	10KΩ														
	Speed Control Range	1 : 5000 (internal speed command) / 1 : 2000 (external analog command)															
	Speed Fluctuation Rate		±0.03% or less at Load fluctuation 0 to 100% (at Rated Speed)														
			±0.2% or less at power fluctuation ±10% (at Rated Speed)														
	Accel/Decel. Time Constant	Linear : 0 ~ 50sec ; S-curve : 0 ~ 5sec ; Ripple : 0 ~ 10sec															
	Frequency Characteristics	800Hz (J _L +J _M)															
Torque Limit Operation	External analog command / Set by internal parameters																
Zero Speed / Speed Reach Range	0 ~ 4500rpm (Set by internal parameters)																
Torque Control Mode	Command Source	External analog command															
	Analog Input Signals	Voltage Range	0 ~ ±10Vdc / 0 ~ ±600%														
		Impedance	10KΩ														
	Accel/Decel. Time Constant	Linear : 0 ~ 50sec; Ripple : 0 ~ 10sec															
	Speed Limit Operation	External analog command / Set by internal parameters															
Torque Reach Range	0 ~ 300% (Set by internal parameters)																
Input/ Output Signal	Position Output	Output Type	Phase A, B, Z Line Drive /Phase Z Open Collector														
		Encoder Ratio	Pulse Output: 1 ~ encoder—pulse numbers (any arbitrary values set by Internal parameters)														
	Digital Input [NPN/PNP]	Programmable 12 points	Servo on, Alarm reset, P/PI switching, CCW/CW switch limited, External torque limit, Pulse deviation clear, Servo lock, Emergency stop, Speed command selection, Control mode switching, Pulse command inhibit, Gain switching, Electric gear ratio setting, Internal pulse command trigger, Internal pulse command pause, Homing, External reference signal, Internal position command selection, Torque/Speed command reverse, Forward/Reverse operation in torque maod. 31 Types of Optional Functions														
	Digital Output [Photocoupler]	Programmable 4 points	Servo alarm code, P mode enable, Torque limit, Drive disable, Base Block. Fix Output Alarm Code														
Analog Output Signal	Programmable 4 points	Servo ready, Servo alarm, Zero speed, Brake interlock, Speed reach, Position completed, Homing completed, Torque reach. 17 Types of Optional Functions															
	Programmable 3 points	Speed feedback, Torque/Speed/Pulse input command, Position deviationvalue, electrical angle, Main circuit voltage[Vdc Bus]. 12 Types of Optional Functions (0~±10Vdc)															
Environment	Installation site	Indoor (avoiding direct sunshine) no erosion air (avoiding oil gases, inflammable gas and dust)															
	Altitude	Sea level 1000m below															
	Temperature	Operating Temperature 0~ 50℃, storage Temperature: -20 ~ +65℃															
	Humidity	Operating, storage below 90% RH															
	Vibration	10 ~ 57Hz : 20m/s ² ; 57 ~ 150Hz : 2G															
Certification	CE	In compliance with EN61800-3 and EN61800-5-1															
	UL	UL508C															

Note : * Coming soon.

System Configuration

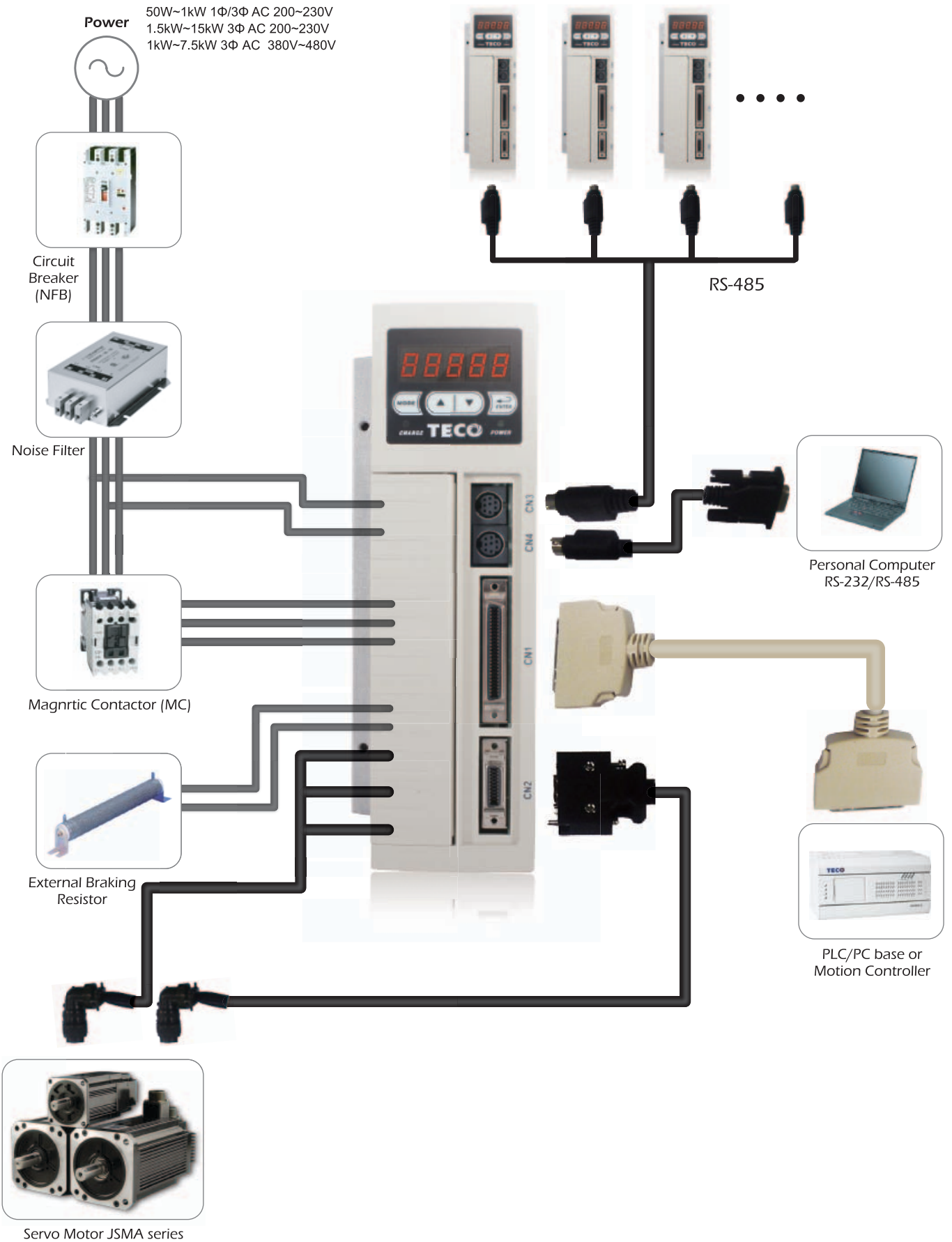

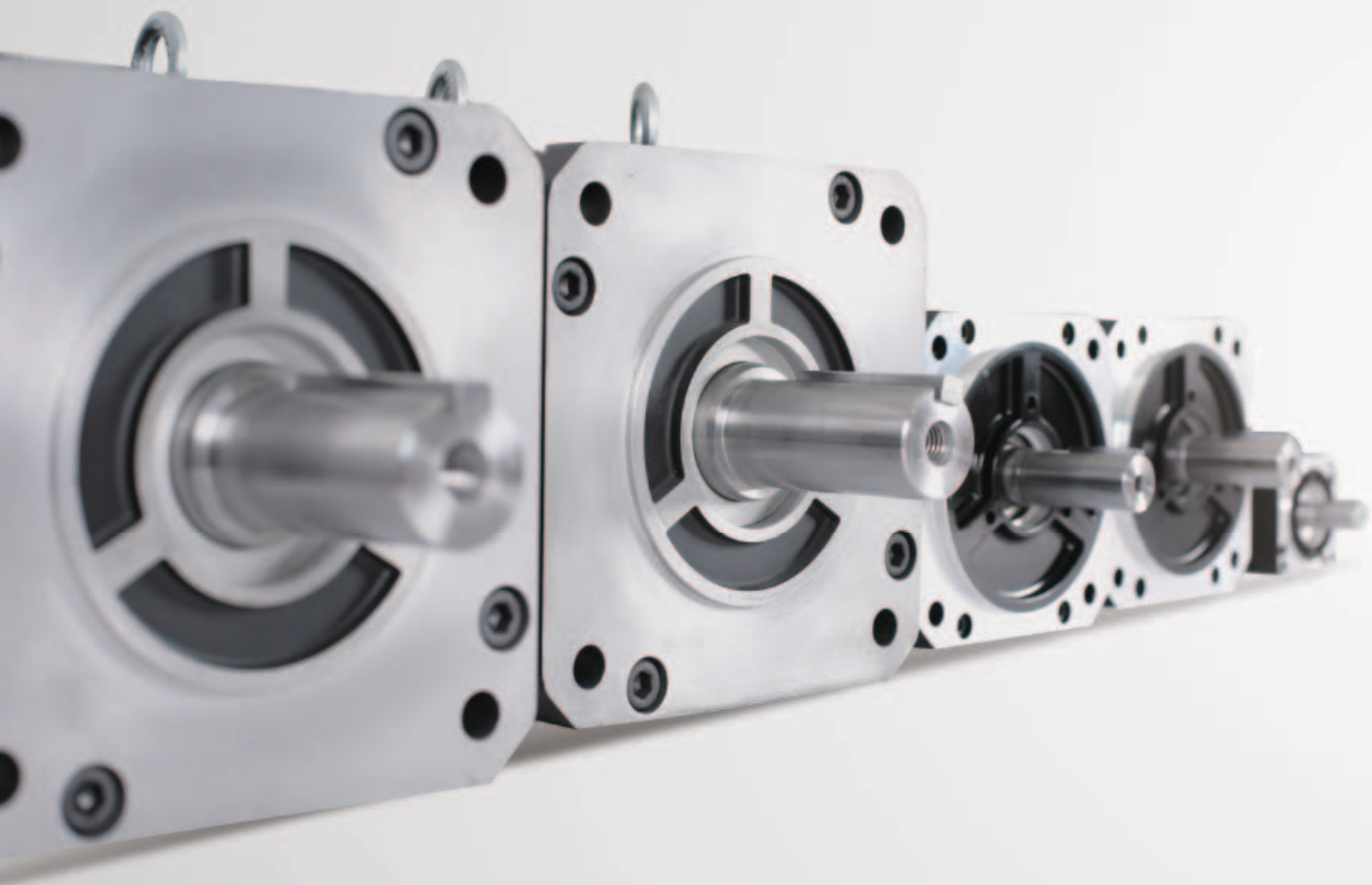

Servo Motor JSMA Series

IP67



Model Designation

JS M A - P S C 08 A H □ □

TECO AC Servo Series

Servo Motor

Series:
AP: A Series

IP67 (except shaft and connectors)

Inertia:
S: Super Low
L: Low
M: Middle
H: Middle

Motor Speed:
A: 1000rpm
B: 2000rpm
C: 3000rpm
H: 1500rpm

Input Voltage:
A: AC 200V Class
B: AC 400V Class

Encoder Resolution:
B: 2500ppr
H: 8192ppr
7: 17-bit
5: 15-bit(absolute)

Rated Output Power:
P5 : 50W 15 : 1.5kW
01 : 100W 20 : 2kW
02 : 200W 30 : 3kW
03 : 300W 44 : 4.4kW
04 : 400W 55 : 5.5kW
05 : 500W 75 : 7.5kW
08 : 750W 110 : 11 kW
10 : 1kW 150 : 15 kW

Mechanical Brake:
□: without brake
B : with brake(24VDC)

No.	Keyway	Oil seal
□	No	No
K	Yes	No
O	No	Yes
A	Yes	Yes

*The information above is for model description, please contacts our sales for more detail.

Standard Specification



200V Class
S/L Series Low Inertia
(50W~750W)

Motor Mode	Symbol	Unit	JSMA-P□□□□							
			200V Class							
			SCP5A	SC01A	SC02A	SC04A	SC08A	LC03A	LC08A	
Standard / Customization			Standard	Standard	Standard	Standard	Standard	Standard	Standard	
Drive Model			10A	10A/15A	10A/15A	15A/20A	20A/30A	15A	20A	
Rated Output	P _R	KW	0.05	0.1	0.2	0.4	0.75	0.3	0.75	
Rated Torque	T _R	N · m	0.16	0.32	0.64	1.27	2.39	0.95	2.39	
Max. Torque	T _{max}	N · m	0.48	0.95	1.91	3.82	7.16	2.86	7.16	
Rated Speed	N _R	rpm	3000							
Max. Speed	N _{max}	rpm	4500				3750	4500	3800	
Rated Current	I _R	A	0.65	0.94	1.80	2.50	4.30	2.00	3.75	
Max. Armature Current	I _{max}	A	1.95	2.82	5.40	7.50	12.90	6.00	11.25	
Torque Constant	K _T	N · m/A	0.36	0.38	0.39	0.51	0.61	0.52	0.77	
Rotor Moment of Inertia	J _M	Kg · cm ²	0.03	0.04	0.17	0.28	0.94	0.68	2.46	
Armature Resistor	R _a	Ω	78.00	25.00	7.50	5.60	2.10	5.58	2.18	
Armature Inductance	L _a	mH	78.0	35.0	16.2	14.5	8.6	11.6	7.7	
Mechanical Time Constant	T _m	ms	2.70	0.94	0.90	0.69	0.81	1.98	1.67	
Electrical Time Constant	T _e	ms	0.34	1.40	2.37	2.59	4.11	2.05	3.53	
Weight(Standard)	W	kgw	0.48	0.70	1.03	1.37	2.47	1.59	3.05	
Insulation Grade	—	—	Class B(130℃)				Class F(155℃)			
Operating Ambient Temp.	T	℃	0~40							
Operating Ambient Humidity	RH	%	<80				<90		<80	
Storage Temp.	T	℃	-20~60							
Storage Humidity	RH	%	<80							

1(kgf · cm)=0.0980665(N · m) ; 1(gf · cm · s)=0.980665(kg · cm²)

Standard Specification

200V Class
M series Medium inertia
(550W~3kW)

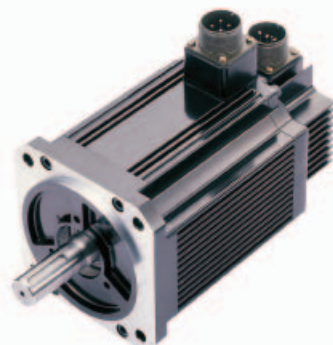

Motor Mode	Symbol	Unit	JSMA-P □□□□						
			200V Class						
			MA05A	MA10A	MA15A	MB10A	MB15A	MB20A	MB30A
Standard / Customization			Standard	Standard	Standard	Standard	Standard	Standard	Standard
Drive Model			20A	30A	30A/50A3	30A	30A/50A3	50A3	75A3
Rated Output	P _R	KW	0.55	1.0	1.5	1.0	1.5	2.0	3.0
Rated Torque	T _R	N · m	5.25	9.55	14.32	4.78	7.16	9.55	14.33
Max. Torque	T _{max}	N · m	15.76	28.65	42.96	14.33	21.49	28.65	42.69
Rated Speed	N _R	rpm	1000			2000			
Max. Speed	N _{max}	rpm	1500	1350	1250	2800		2500	
Rated Current	I _R	A	3.43	5.16	7.45	5.16	7.57	9.18	14.00
Max. Armature Current	I _{max}	A	10.30	15.50	22.35	15.50	22.71	27.50	42.00
Torque Constant	K _T	N · m/A	1.68	2.04	2.11	1.02	1.04	1.14	1.13
Rotor Moment of Inertia	J _M	Kg · cm ²	6.26	12.14	17.92	6.26	8.88	12.14	17.92
Armature Resistor	R _a	Ω	3.58	1.85	1.19	1.22	0.79	0.58	0.33
Armature Inductance	L _a	mH	18.3	12.1	8.4	6.7	4.7	3.8	2.1
Mechanical Time Constant	T _m	ms	1.19	0.81	0.72	1.09	0.98	0.80	0.70
Electrical Time Constant	T _e	ms	5.12	6.55	7.09	5.52	6.00	6.59	6.38
Weight(Standard)	W	kgw	6.49	10.16	13.87	6.47	8.08	10.16	13.87
Insulation Grade	—	—	Class B(130℃)						
Operating Ambient Temp.	T	℃	0~40						
Operating Ambient Humidity	RH	%	<90						
Storage Temp.	T	℃	-20~60						
Storage Humidity	RH	%	<90						

1(kgf · cm)=0.0980665(N · m) ; 1(gf · cm · s²)=0.980665(kg · cm²)

Motor Mode	Symbol	Unit	JSMA-P □□□□					
			200V Class					
			MH05A	MH10A	MC10A	MC15A	MC20A	MC30A
Standard / Customization			Customization	Customization	Customization	Customization	Customization	Customization
Drive Model			20A	30A	30A	30A/50A3	50A3	75A3
Rated Output	P _R	KW	0.55	1.0	1.0	1.5	2.0	3.0
Rated Torque	T _R	N · m	3.50	6.40	3.20	4.78	6.37	9.55
Max. Torque	T _{max}	N · m	10.51	19.21	9.60	14.33	19.11	28.65
Rated Speed	N _R	rpm	1500		3000			
Max. Speed	N _{max}	rpm	2000		3700		3850	
Rated Current	I _R	A	2.98	5.00	4.96	7.06	9.50	14.00
Max. Armature Current	I _{max}	A	8.94	15.00	14.88	21.20	28.50	42.00
Torque Constant	K _T	N · m/A	1.29	1.41	0.72	0.74	0.74	0.75
Rotor Moment of Inertia	J _M	Kg · cm ²	6.26	12.14	4.60	6.26	8.88	12.54
Armature Resistor	R _a	Ω	2.31	0.95	1.02	0.65	0.40	0.25
Armature Inductance	L _a	mH	10.8	8.8	5.1	3.6	2.4	1.6
Mechanical Time Constant	T _m	ms	1.33	0.89	1.39	1.12	0.97	0.81
Electrical Time Constant	T _e	ms	4.68	9.28	4.96	5.48	6.00	6.57
Weight(Standard)	W	kgw	6.47	10.16	5.29	6.47	8.08	10.16
Insulation Grade	—	—	Class B(130℃)					
Operating Ambient Temp.	T	℃	0~40					
Operating Ambient Humidity	RH	%	<90					
Storage Temp.	T	℃	-20~60					
Storage Humidity	RH	%	<90					

1(kgf · cm)=0.0980665(N · m) ; 1(gf · cm · s²)=0.980665(kg · cm²)

Standard Specification

200V Class
MH/HH series Medium inertia
(3kW~15kW)



Motor Mode	Symbol	Unit	JSMA-P □□□□											
			200V Class											
			MH30A	MH44A	MH55A	MH75A	MH110A	MH150A	HH30A	HH44A	HH55A	HH75A		
Standard / Customization			Standard	Standard	Standard	Standard	Standard	Standard	Standard	Standard	Standard	Standard	Standard	Standard
Drive Model			75A3	100A3	150A3	200A3	300A3	300A3	100A3	150A3	200A3	300A3		
Rated Output	P _R	KW	3	4.4	5.5	7.5	11	15	3	4.4	5.5	7.5		
Rated Torque	T _R	N · m	19.1	28	35.1	47.8	70.1	95.5	19.1	28	35.1	47.8		
Max. Torque	T _{max}	N · m	49.5	71.5	89.6	122.6	179	204	49.5	71.4	89.6	122.6		
Rated Speed	N _R	rpm	1500						3000					
Max. Speed	N _{max}	rpm	2000						3000					
Rated Current	I _R	A	15	22.5	28.5	38	58	78	23	33.2	42.1	58		
Max. Armature Current	I _{max}	A	39	58.5	74.1	98.8	152	170	59.8	86.3	109.5	151		
Torque Constant	K _T	N · m/A	1.27	1.24	1.23	1.26	1.21	1.22	0.83	0.84	0.83	0.82		
Rotor Moment of Inertia	J _M	Kg · cm ²	39.99	51.44	63.52	93.94	160.94	222.20	39.99	53.02	63.52	93.94		
Armature Resistor	R _a	Ω	0.18	0.12	0.09	0.05	0.03	0.02	0.08	0.05	0.04	0.02		
Armature Inductance	L _a	mH	2.89	1.98	1.52	1.02	0.8	0.5	1.48	0.89	0.68	0.43		
Mechanical Time Constant	T _m	ms	0.69	0.6	0.56	0.49	0.48	0.37	0.7	0.62	0.56	0.51		
Electrical Time Constant	T _e	ms	16.12	16.81	17.24	18.96	26.77	29.12	18.75	16.54	17.46	18		
Weight(Standard)	W	kgw	19.5	26.2	30	42	52.5	70.5	19.5	26.2	30	42		
Insulation Grade	—	—	Class F (155°C)											
Operating Ambient Temp.	T	°C	0 ~ 40											
Operating Ambient Humidity	RH	%	<90											
Storage Temp.	T	°C	-20 ~ 60											
Storage Humidity	RH	%	<90											

1(kgf · cm)=0.0980665(N · m) ; 1(gf · cm · s²)=0.980665(kg · cm²)

400V Class
MB/MH series Medium inertia
(1kW~7.5kW)

Motor Mode	Symbol	Unit	JSMA-P □□□□										
			400V Class										
			MB10B	MB15B	MB20B	MB30B	MH30B	MH44B	MH55B	MH75B			
Standard / Customization			Standard	Standard	Standard	Standard	Standard	Standard	Standard	Standard	Standard	Standard	Standard
Drive Model			25B	25B	25B	35B	35B	50B	75B	100B			
Rated Output	P _R	KW	1.0	1.5	2.0	3.0	3	4.4	5.5	7.5			
Rated Torque	T _R	N · m	4.782	7.164	9.545	14.327	19.1	28.0	35.1	47.8			
Max. Torque	T _{max}	N · m	14.327	21.492	28.645	42.693	47.8	70.0	87.8	119.5			
Rated Speed	N _R	rpm	2000				1500						
Max. Speed	N _{max}	rpm	2800		2500		2000						
Rated Current	I _R	A	2.58	4.36	5.78	8.9	8.0	11.5	16.0	22.0			
Max. Armature Current	I _{max}	A	7.74	13.08	17.34	26.7	20.8	29.9	41.6	57.2			
Torque Constant	K _T	N · m/A	2.06	1.80	1.76	1.78	2.39	2.43	2.19	2.17			
Rotor Moment of Inertia	J _M	Kg · cm ²	6.26	8.88	12.14	17.92	43.70	61.77	77.98	112.20			
Armature Resistor	R _a	Ω	5.38	2.39	1.45	1.07	0.64	0.38	0.20	0.12			
Armature Inductance	L _a	mH	23	12	8.96	5.89	14.94	9.34	5.00	3.19			
Mechanical Time Constant	T _m	ms	1.32	0.97	0.865	0.93	0.75	0.60	0.48	0.44			
Electrical Time Constant	T _e	ms	4.28	5.02	6.18	5.5	23.45	24.51	25.63	26.82			
Weight(Standard)	W	kgw	6.47	8.08	10.16	13.87	17.5	22.5	27.0	36.5			
Insulation Grade	—	—	Class B(130°C)				Class F(155°C)						
Operating Ambient Temp.	T	°C	0 ~ 40										
Operating Ambient Humidity	RH	%	<90										
Storage Temp.	T	°C	-20 ~ 60										
Storage Humidity	RH	%	<90										

1(kgf · cm)=0.0980665(N · m) ; 1(gf · cm · s²)=0.980665(kg · cm²)

Dimension

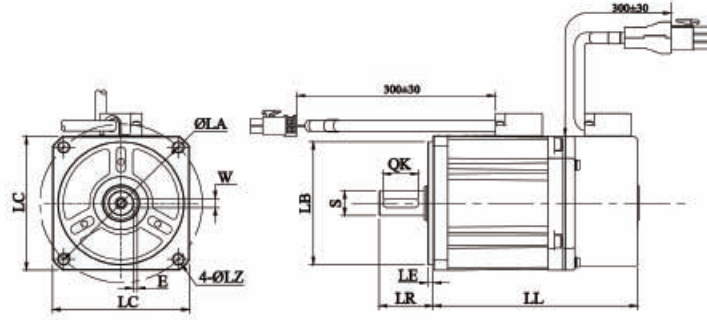

Servo Motor Model		LZ ψ	L $\alpha\psi$	LC	E	W	S ψ	LB ψ	QK	LE	LR	LL	
JSMA-PL Series	Without Brake	LC03AB/H	ψ 5.5	ψ 90	76	2	5	ψ 14	ψ 70	20	3	30	113.4
		LC08AB/H	ψ 6.5	ψ 100	86	2	5	ψ 16	ψ 80	25	3	35	148
		LC08AB/H-OC	ψ 6.5	ψ 100	86	2	5	ψ 19	ψ 80	25	3	35	148
	With Brake	LC03AB/H	ψ 5.5	ψ 90	76	2	5	ψ 14	ψ 70	20	3	30	147.8
		LC08AB/H	ψ 6.5	ψ 100	86	2	5	ψ 16	ψ 80	25	3	35	183.2
		LC08AB/H-OC	ψ 6.5	ψ 100	86	2	5	ψ 19	ψ 80	25	3	35	183.2
JSMA-PS Series	Without Brake	SCP5AB/H	ψ 3.5	ψ 48	42	-	-	ψ 8	ψ 30	16	2.5	25.5	85.3
		SC01AB/H	ψ 3.5	ψ 48	42	-	-	ψ 8	ψ 30	16	2.5	25	106.8
		SC02AB/H	ψ 5.5	ψ 70	60	2	5	ψ 14	ψ 50	22	3	30	114.8
		SC04AB/H	ψ 5.5	ψ 70	60	2	5	ψ 14	ψ 50	22	3	30	132.8
		SC08AB/H	ψ 5.5	ψ 90	80	2.5	6	ψ 19	ψ 70	30	3	40	139
		SC01AB/H	ψ 3.5	ψ 48	42	-	-	ψ 8	ψ 30	16	2.5	25	144.1
	With Brake	SC02AB/H	ψ 5.5	ψ 70	60	2	5	ψ 14	ψ 50	22	3	30	147.3
		SC04AB/H	ψ 5.5	ψ 70	60	2.5	5	ψ 14	ψ 50	22	3	30	167.3
		SC08AB/H	ψ 5.5	ψ 90	80	2.5	6	ψ 19	ψ 70	30	3	40	172

Unit:mm

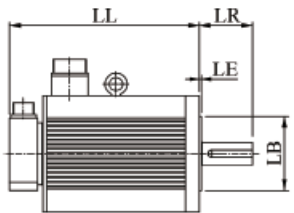
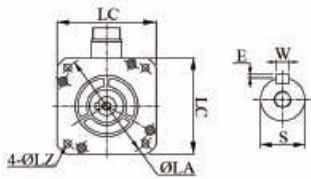

Servo Motor Model		LZ ψ	L $\alpha\psi$	LC	E	W	S ψ	LB ψ	LE	LR	LL		
JSMA-PM JSMA-PH Series	200V Class	Without Brake	MA05A	ψ 9	ψ 145	130.4	2.5	6	ψ 22	ψ 110	6	58	163.8
			MH05A	ψ 9	ψ 145	130.4	2.5	6	ψ 22	ψ 110	6	58	163.8
			MA10A	ψ 9	ψ 145	130.4	2.5	6	ψ 22	ψ 110	6	58	213.8
			MB10A	ψ 9	ψ 145	130.4	2.5	6	ψ 22	ψ 110	6	58	163.8
			MC10A	ψ 9	ψ 145	130.4	2.5	6	ψ 22	ψ 110	6	58	148.8
			MH10A	ψ 9	ψ 145	130.4	2.5	6	ψ 22	ψ 110	6	58	213.8
			MA15A	ψ 9	ψ 145	130.4	2.5	6	ψ 22	ψ 110	6	58	263.8
			MB15A	ψ 9	ψ 145	130.4	2.5	6	ψ 22	ψ 110	6	58	184.8
			MC15A	ψ 9	ψ 145	130.4	2.5	6	ψ 22	ψ 110	6	58	163.8
			MB20A	ψ 9	ψ 145	130.4	2.5	6	ψ 22	ψ 110	6	58	213.8
			MC20A	ψ 9	ψ 145	130.4	2.5	6	ψ 22	ψ 110	6	58	184.8
			MB30A	ψ 9	ψ 145	130.4	2.5	6	ψ 22	ψ 110	6	58	263.8
			MC30A	ψ 9	ψ 145	130.4	2.5	6	ψ 22	ψ 110	6	58	213.8
			MH30A	ψ 13.5	ψ 200	180	3	10	ψ 35	ψ 114.3	3.2	79	254
			MH44A	ψ 13.5	ψ 200	180	3	10	ψ 35	ψ 114.3	3.2	79	283
			MH55A	ψ 13.5	ψ 200	180	3	12	ψ 42	ψ 114.3	3.2	113	297
			MH75A	ψ 13.5	ψ 200	180	3	12	ψ 42	ψ 114.3	3.2	113	382
			MH110A	ψ 13.5	ψ 235	220	3	12	ψ 42	ψ 200	4	116	352
			MH150A	ψ 13.5	ψ 235	220	4	16	ψ 55	ψ 200	4	116	429
			HH30A	ψ 13.5	ψ 200	180	3	10	ψ 35	ψ 114.3	3.2	79	245
			HH44A	ψ 13.5	ψ 200	180	3	10	ψ 35	ψ 114.3	3.2	79	273.5
	HH55A	ψ 13.5	ψ 200	180	3	12	ψ 42	ψ 114.3	3.2	113	282.5		
	HH75A	ψ 13.5	ψ 200	180	3	12	ψ 42	ψ 114.3	3.2	113	371		
	400V Class	Without Brake	MA05A	ψ 9	ψ 145	130.4	2.5	6	ψ 22	ψ 110	6	58	218.3
			MH05A	ψ 9	ψ 145	130.4	2.5	6	ψ 22	ψ 110	6	58	218.3
			MA10A	ψ 9	ψ 145	130.4	2.5	6	ψ 22	ψ 110	6	58	268.3
			MB10A	ψ 9	ψ 145	130.4	2.5	6	ψ 22	ψ 110	6	58	218.3
			MC10A	ψ 9	ψ 145	130.4	2.5	6	ψ 22	ψ 110	6	58	203.3
			MH10A	ψ 9	ψ 145	130.4	2.5	6	ψ 22	ψ 110	6	58	268.3
			MA15A	ψ 9	ψ 145	130.4	2.5	6	ψ 22	ψ 110	6	58	318.3
			MB15A	ψ 9	ψ 145	130.4	2.5	6	ψ 22	ψ 110	6	58	238.3
			MC15A	ψ 9	ψ 145	130.4	2.5	6	ψ 22	ψ 110	6	58	218.3
			MB20A	ψ 9	ψ 145	130.4	2.5	6	ψ 22	ψ 110	6	58	268.3
			MC20A	ψ 9	ψ 145	130.4	2.5	6	ψ 22	ψ 110	6	58	238.3
			MB30A	ψ 9	ψ 145	130.4	2.5	6	ψ 22	ψ 110	6	58	318.3
		With Brake	MC30A	ψ 9	ψ 145	130.4	2.5	6	ψ 22	ψ 110	6	58	268.3
			MB10B	ψ 9	ψ 145	130.4	2.5	6	ψ 22	ψ 110	6	58	163.8
			MB15B	ψ 9	ψ 145	130.4	2.5	6	ψ 22	ψ 110	6	58	183.8
			MB20B	ψ 9	ψ 145	130.4	2.5	6	ψ 22	ψ 110	6	58	213.8
			MB30B	ψ 9	ψ 145	130.4	2.5	6	ψ 22	ψ 110	6	58	263.8
			MH30B	ψ 13.5	ψ 200	180	3	10	ψ 35	ψ 114.3	3.2	79	221
			MH44B	ψ 13.5	ψ 200	180	3	10	ψ 35	ψ 114.3	3.2	79	249
MH55B			ψ 13.5	ψ 200	180	3	12	ψ 42	ψ 114.3	3.2	113	275	
MH75B			ψ 13.5	ψ 200	180	3	12	ψ 42	ψ 114.3	3.2	113	330	
With Brake	MB10B	ψ 9	ψ 145	130.4	2.5	6	ψ 22	ψ 110	6	58	218.3		
	MB15B	ψ 9	ψ 145	130.4	2.5	6	ψ 22	ψ 110	6	58	238.3		
	MB20B	ψ 9	ψ 145	130.4	2.5	6	ψ 22	ψ 110	6	58	268.3		
MB30B	ψ 9	ψ 145	130.4	2.5	6	ψ 22	ψ 110	6	58	318.3			

Unit:mm



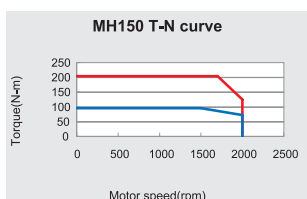
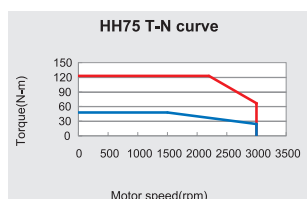
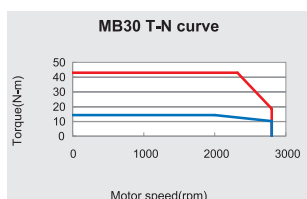
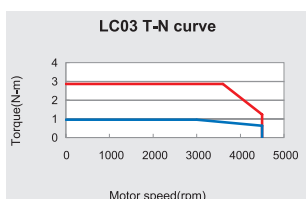
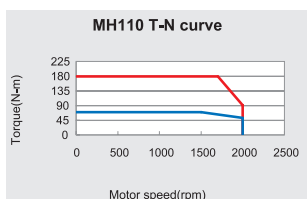
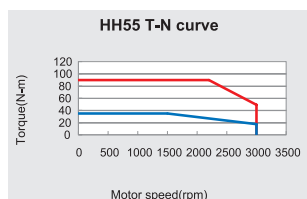
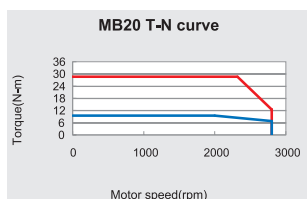
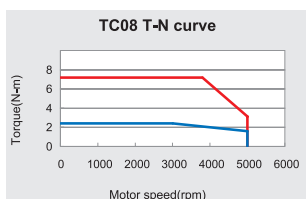
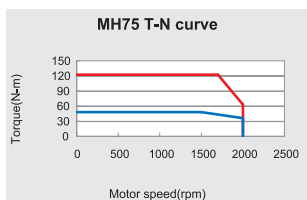
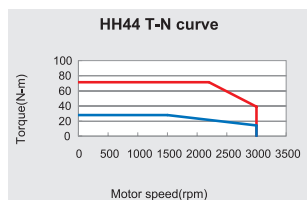
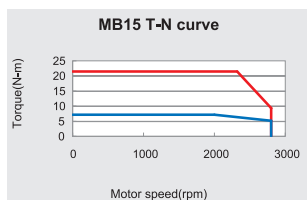
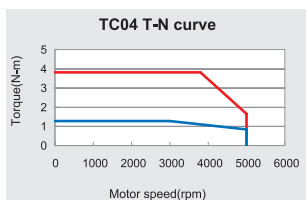
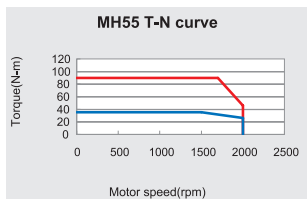
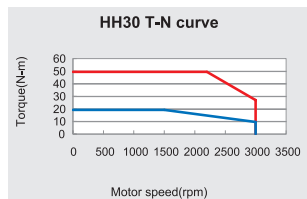
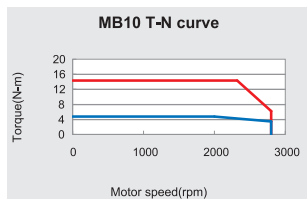
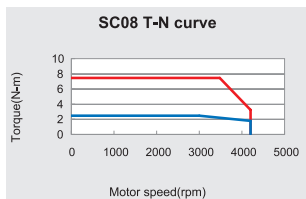
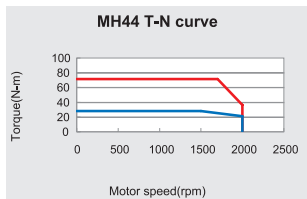
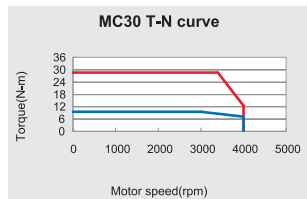
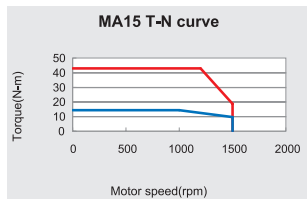
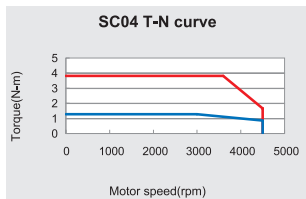
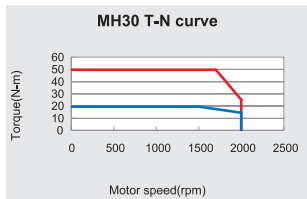
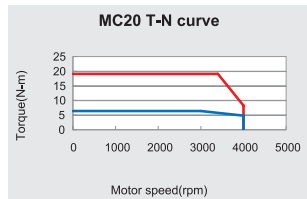
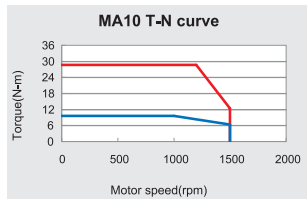
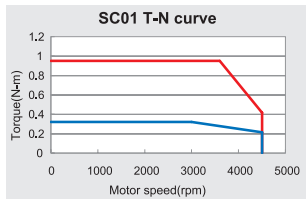
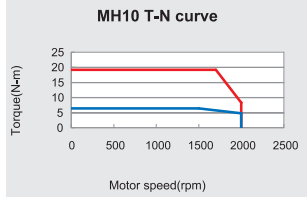
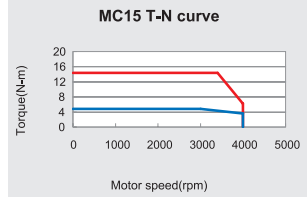
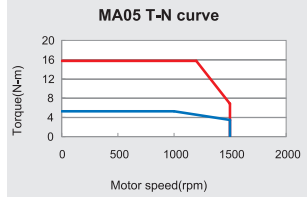
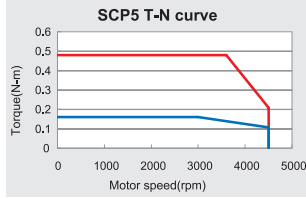
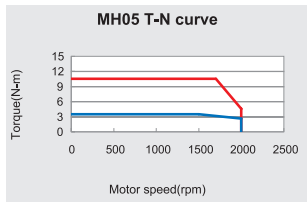
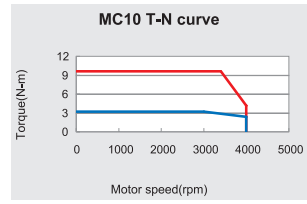
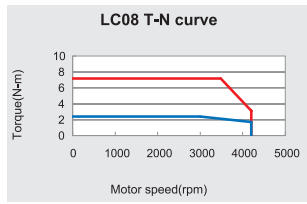
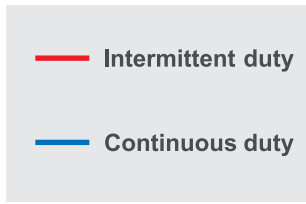

Performance Curve

200V Class

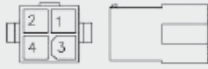

Accessories

Power Connectors

Part No.	Description	Model
JSSCNM04	For JSMA-S/L Series (50W~750W)	 CAP: 172159-1 SCOKET: 170362-1
JSSCNML04	For JSMA-M Series without brake (550W~3kW)	 CONNECTOR: MS3108A20-4S MS3057-12A(SR)
JSSCNBL04	For JSMA-MM/MH Series without brake (3kW~15kW)	 CONNECTOR: MS3108A32-17S MS3057-20A(SR)
JSSCNML07	For JSMA-M Series with brake (550W~3kW)	 CONNECTOR: MS3108A20-15S MS3057-12A(SR)

Power Connectors

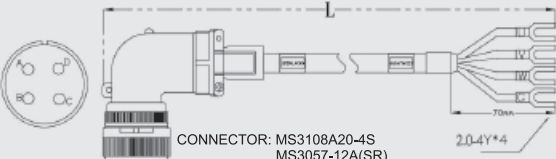
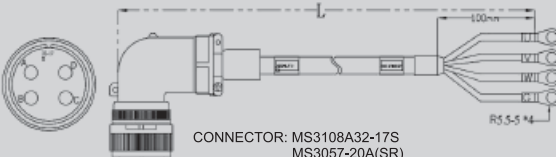

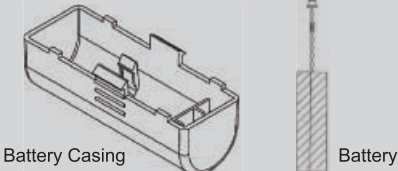

Part No.	L (Meter)	Description	Model
JSSLM001	1	For JSMA-S/L Series (50W~750W)	 CAP: 172159-1 SCOKET: 170362-1 1.25-4Y
JSSLM003	3		
JSSLM005	5		
JSSLM010	10		
JSSLM015	15		
JSSLM020	20		
JSSMLM001	1	For JSMA-M Series without brake (550W~3kW)	 CONNECTOR: MS3108A20-4S MS3057-12A(SR) 2.0-4Y*4
JSSMLM003	3		
JSSMLM005	5		
JSSMLM010	10		
JSSMLM015	15		
JSSMLM020	20		
JSSBLM001	1	For JSMA-MM/MH Series without brake (3kW~15kW)	 CONNECTOR: MS3108A32-17S MS3057-20A(SR) R5.5-5*4
JSSBLM003	3		
JSSBLM005	5		
JSSBLM010	10		
JSSBLM015	15		
JSSBLM020	20		

Battery Module (For JSDA+ Series)

Part No.	Description	Model
JSSBAT	For absolute encoder	 Battery Casing Battery

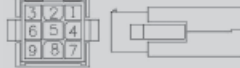
Accessories

Encoder Connectors

Part No.	Description	Model
JSSCNP09	For JSMA-S/L Series	 CONNECTOR: 172161-1 TERMINAL: 170361-1
JSSCNPL09	For JSMA-M Series	 CONNECTOR: MS3108A20-18S MS3057-12A(SR)
JSSCN20P	For JSDA+ Series (CN2)	 CONNECTOR: 10320-52A0-008 12120-3000PE
JSSECN09P	For JSDE+ Series (CN2)	 CONNECTOR: D-SUB9PM Male COVER: DC-9CT Screw

Encoder Cables (For JSDA+ Series 15-bit / 17-bit encoders)

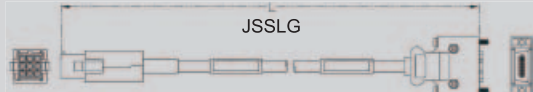
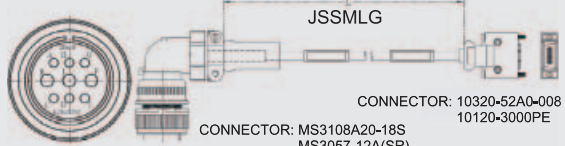
Part No.	L (Meter)	Description	Model
JSSLG001	1	For JSMA-S/L Series and JSDA+ Amplifiers	 CONNECTOR: 172161-1 TERMINAL: 170361-1 CONNECTOR: 10320-52A0-008 10120-3000PE
JSSLG003	3		
JSSLG005	5		
JSSLG010	10		
JSSLG015	15		
JSSLG020	20		
JSSMLG001	1	For JSMA-M Series and JSDA+ Amplifiers	 CONNECTOR: MS3108A20-18S MS3057-12A(SR) CONNECTOR: 10320-52A0-008 10120-3000PE
JSSMLG003	3		
JSSMLG005	5		
JSSMLG010	10		
JSSMLG015	15		
JSSMLG020	20		

Encoder Cables (For JSDA+ Series 2500ppr / 8192ppr encoders)

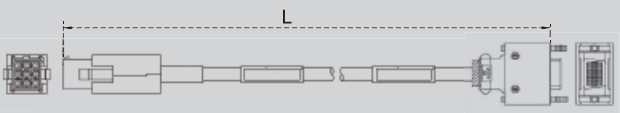
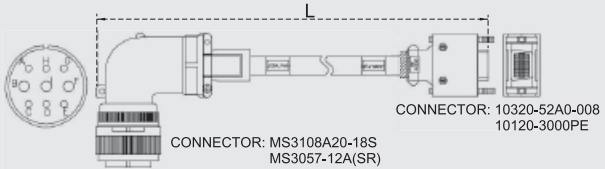
Part No.	L (Meter)	Description	Model
JSSLP001	1	For JSMA-S / L / T Series and JSDA+ Series	 CONNECTOR: 172161-1 TERMINAL: 170361-1 CONNECTOR: 10320-52A0-008 10120-3000PE
JSSLP003	3		
JSSLP005	5		
JSSLP010	10		
JSSLP015	15		
JSSLP020	20		
JSSMLP001	1	For JSMA-S / L / T Series and JSDA+ Series	 CONNECTOR: MS3108A20-18S MS3057-12A(SR) CONNECTOR: 10320-52A0-008 10120-3000PE
JSSMLP003	3		
JSSMLP005	5		
JSSMLP010	10		
JSSMLP015	15		
JSSMLP020	20		

Encoder Cables (For JSDE+ Series 2500ppr / 8192ppr encoders)

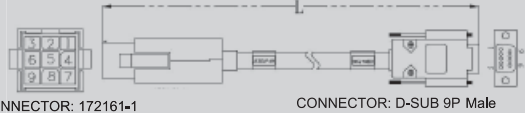
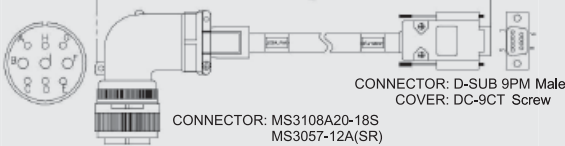
Part No.	L (Meter)	Description	Model
JSSERP001	1	For JSMA-S/L Series and JSDE+ Series	 CONNECTOR: 172161-1 TERMINAL: 170361-1 CONNECTOR: D-SUB 9P Male COVER: DC-9CT Screw
JSSERP003	3		
JSSERP005	5		
JSSERP010	10		
JSSERP015	15		
JSSERP020	20		
JSSEMLP001	1	For JSMA-M Series and JSDE+ Series	 CONNECTOR: MS3108A20-18S MS3057-12A(SR) CONNECTOR: D-SUB 9PM Male COVER: DC-9CT Screw
JSSEMLP003	3		
JSSEMLP005	5		
JSSEMLP010	10		
JSSEMLP015	15		
JSSEMLP020	20		

Accessories

I/O Signal Connector

Part No.	Description	Model
JSSCN50P	For JSDA ⁺ Series (CN1)	CONNECTOR: 10350-52A0-008 10150-3000PE
JSSECN25P	For JSDE ⁺ Series (CN1)	CONNECTOR: D-SUB 25P M Male COVER: DC-25 CT Screw

Terminal Block (For JSDA⁺ Series)

Part No.	L (Meter)	Description	Model
JSSTBC0P5	0.5	For JSDA ⁺ Series	<p>Shell kit: 10350-3210-000*2 SCSI II: 10150-600PE*2</p>
JSSTBC001	1		
JSSTBC002	2		
JSSTB50P	—	For JSDA ⁺ Series	

Terminal Block (For JSDE⁺ Series)

Part No.	L (Meter)	Description	Model
JSSETBC0P5	0.5	For JSDE ⁺ Series	<p>CONNECTOR: D-SUB 25P M Male × 2 COVER: DC-25 CT Screw × 2</p>
JSSETBC001	1		
JSSETBC002	2		
JSSETB25P	—	For JSDE ⁺ Series	

Communication Cables

Part No.	L (Meter)	Description	Model
JSSDTC001	1	Connection to PC	<p>D-9S MD-8P</p>
JSSDTC002	2		
JSSDTD001	1	Connection to Drive	<p>MD-8P MD-8P</p>
JSSDTD002	2		

Distributor



TECO ELECTRIC & MACHINERY CO., LTD.

10F, No. 3-1, Yuan Cyu St., Nan-Kang District, Taipei 115, Taiwan

TEL : 886-2-6615-9111Ext.1725

FAX : 886-2-6615-1033

<http://global.teco.com.tw>

Specifications covered in this brochure may be subject to change without notice.

GJ-60-01 2013-07-01